

()

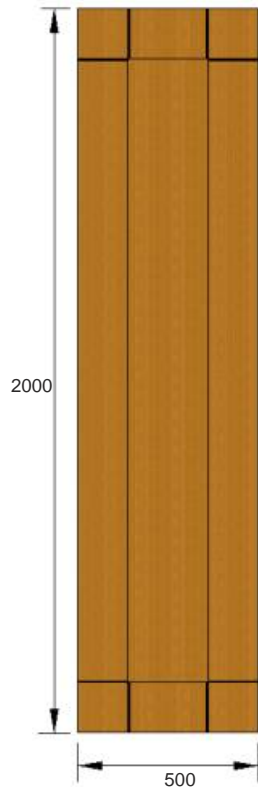

()

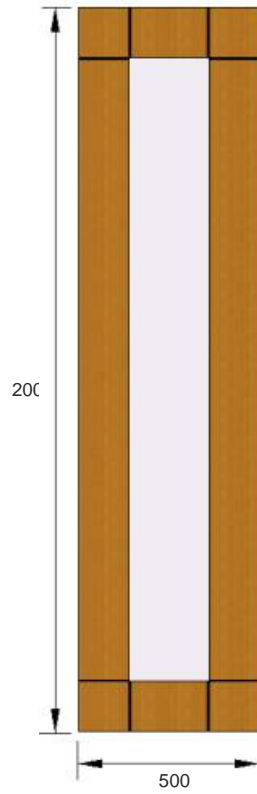

- . - .

.

4.

40 .

40 .

" " " "

33.1.02

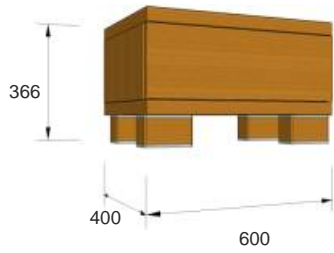

2

33.1.23

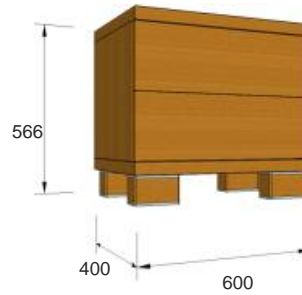

33.1.03

1

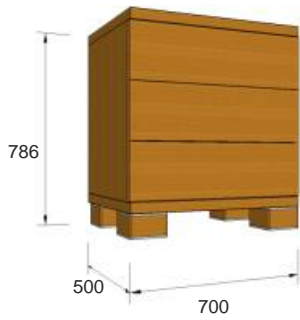

2

33.1.04

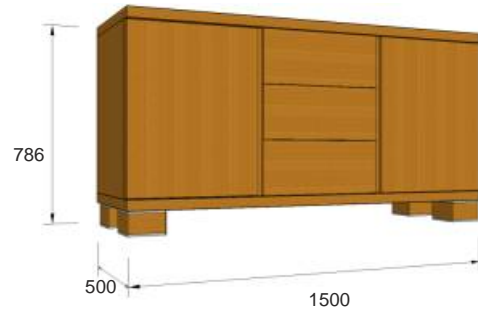

33.1.05

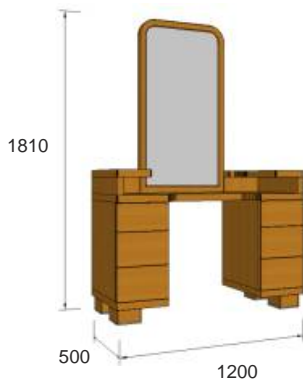

1

33.1.24 ()

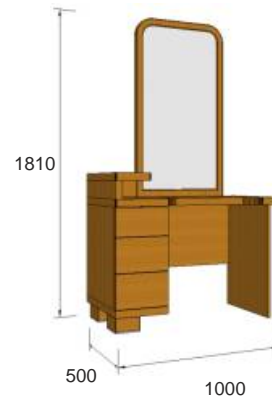

33.3.06



33.1.25

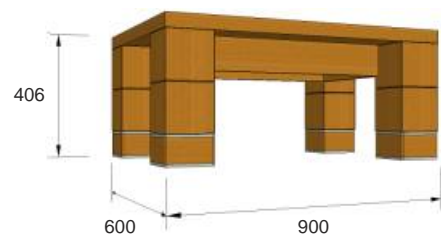

33.1.07

1-

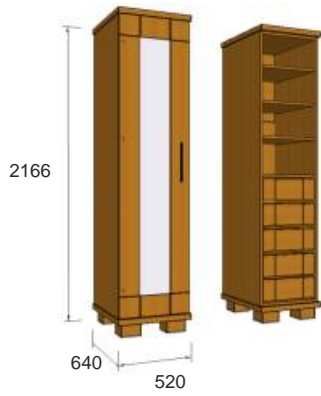

33.1.08

1-

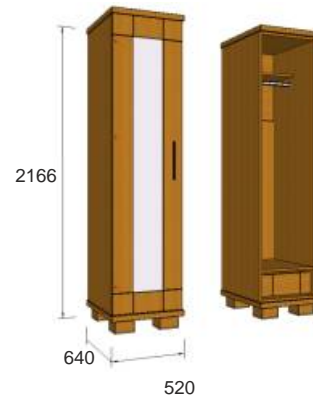

33.1.09

2-

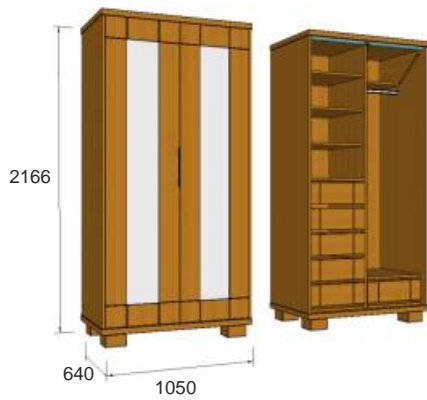

33.1.10

2-



33.1.12

2-



33.1.14

2-



33.1.21

1**

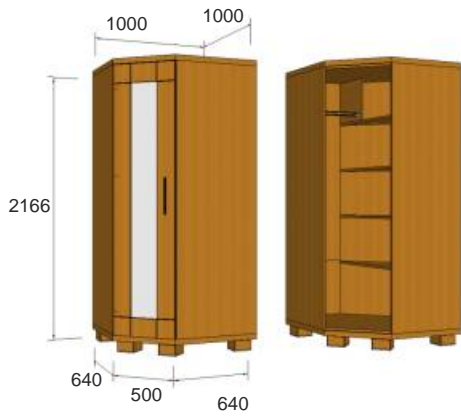

**

33.1.22

2**

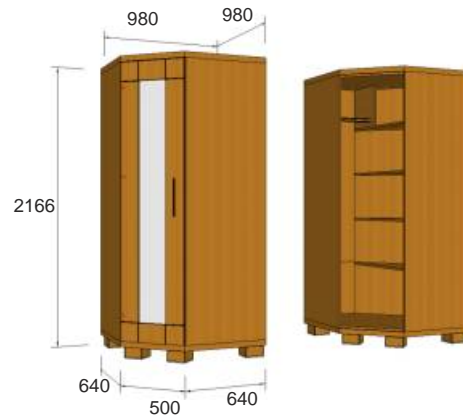

**

* - 33.1.31 -

2

33.1.15

(3- 1)

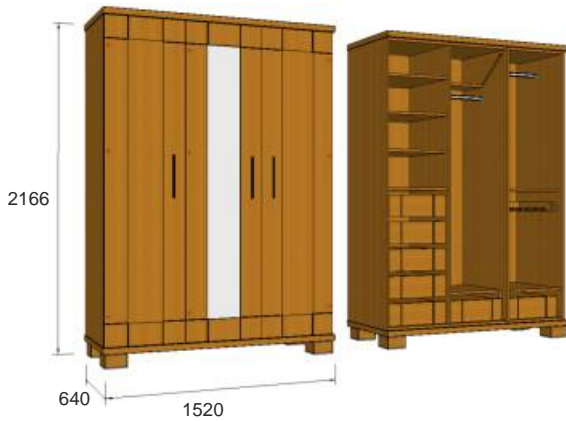

33.1.16

(3- 2)



33.1.17

4-

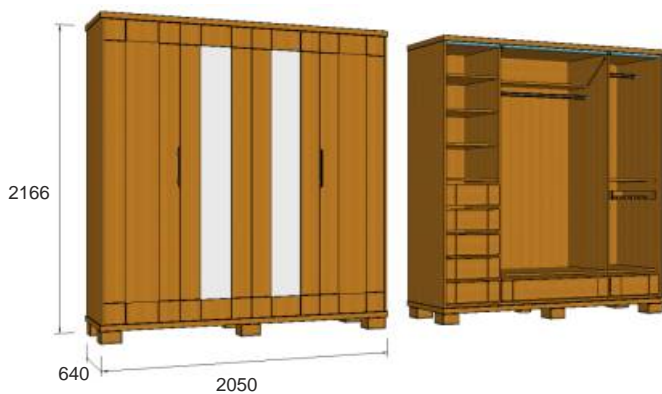

33.1.18

4-

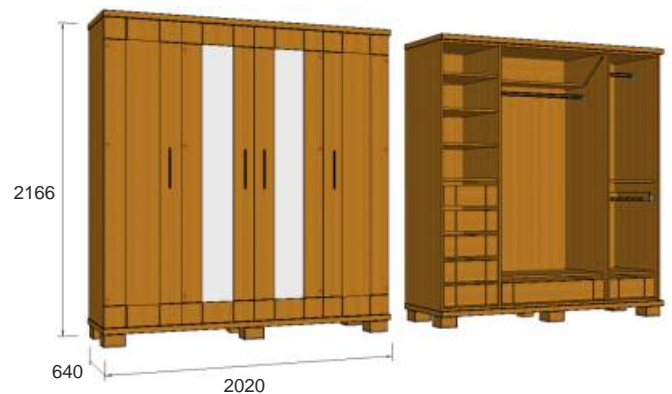

33.1.19

6-



33.1.20

6-

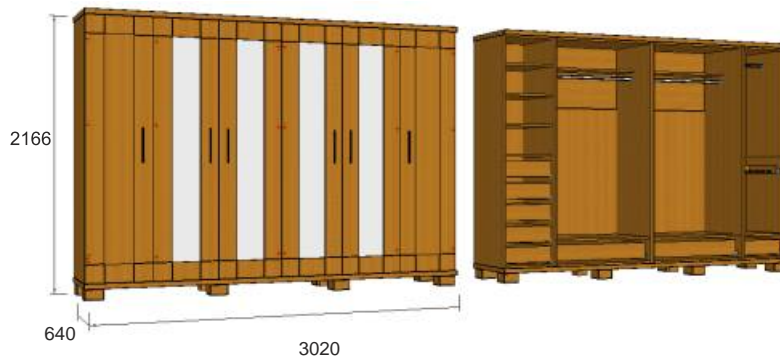

33.1.01

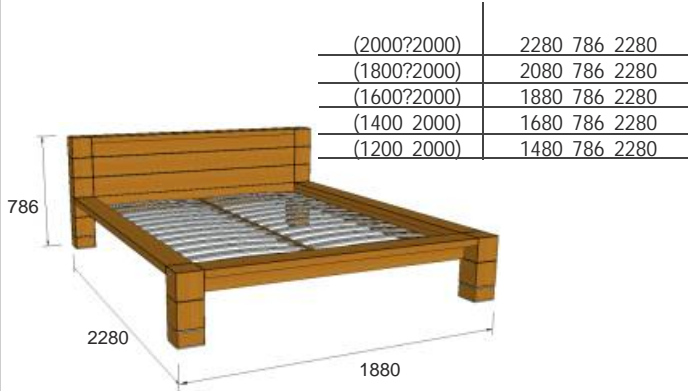

33.1.28

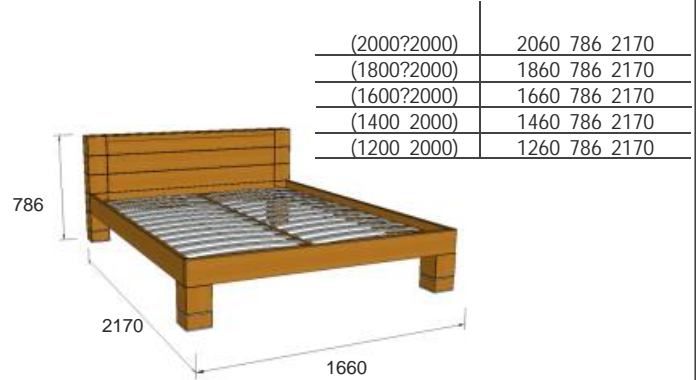

33.1.26

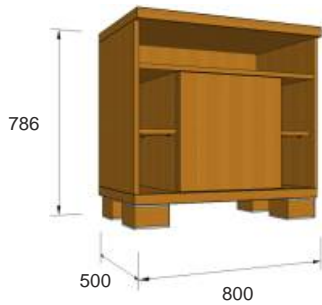

33.1.27



33.1.29

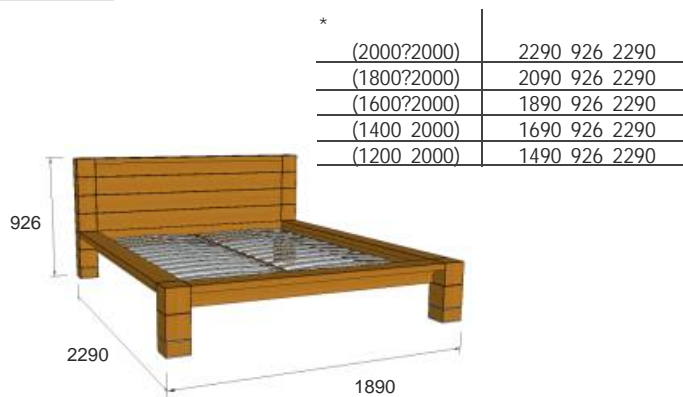

33.1.30

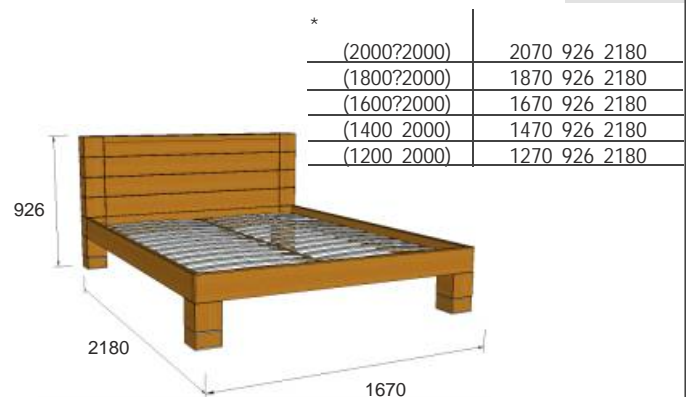

33.1.01

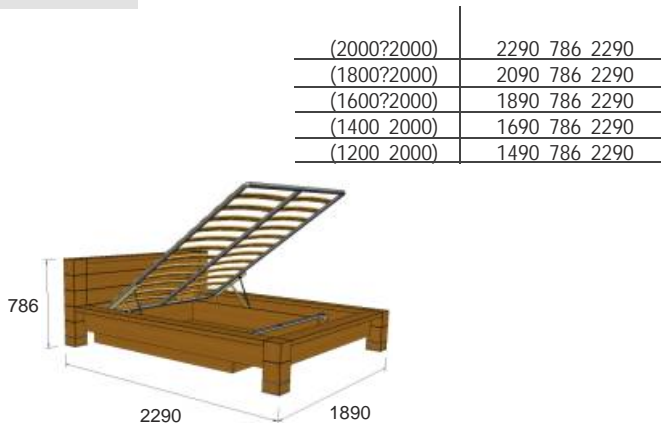

33.1.28

